

SFS intec Fastener Color Selection



Fibersin recommends 300 series austenitic stainless steel cladding fasteners by SFS intec when installing Stonewood Architectural Panels for exterior rainscreen applications.

300 series austenitic stainless steel cladding fasteners are specifically designed to be corrosion resistant and are available with plain finish and in colors matched to Stonewood Architectural Panels.

Application

SX3 TORX® Fastener

SFS intec Part #:	1271253
Code:	SX3/15-D12-5,5X30
Description:	12-11 x 1-3/16"
Head Style:	T25 TORX® Pan Head
Diameter:	Nominal #12
Drill Capacity:	.060"-.118"
Max. Material Attachment:	.590"

SX3 TORX® is an austenitic stainless steel fastener with a bi-metal welded carbon steel point.

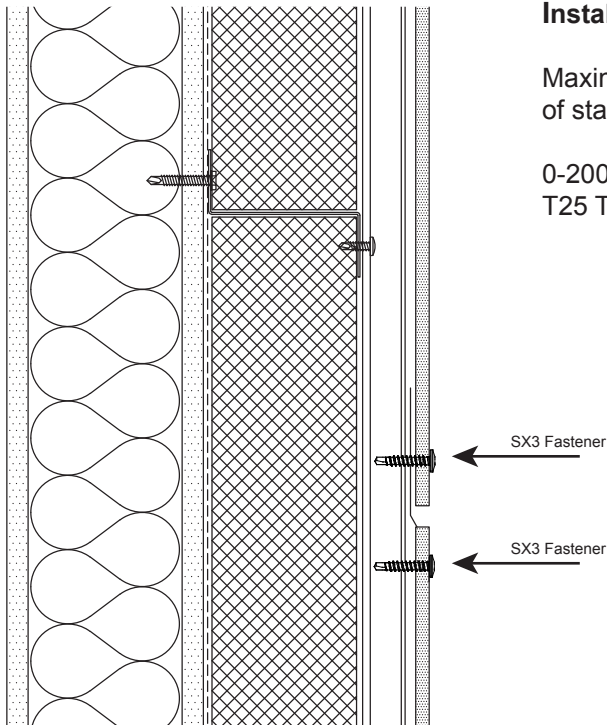

Installation:

Maximum material attachment (.590") is from underside of head to end of stainless steel thread.

0-2000 rpm screw gun equipped with depth sensing nosepiece.
T25 TORX® drive bit required for SX3 TORX.

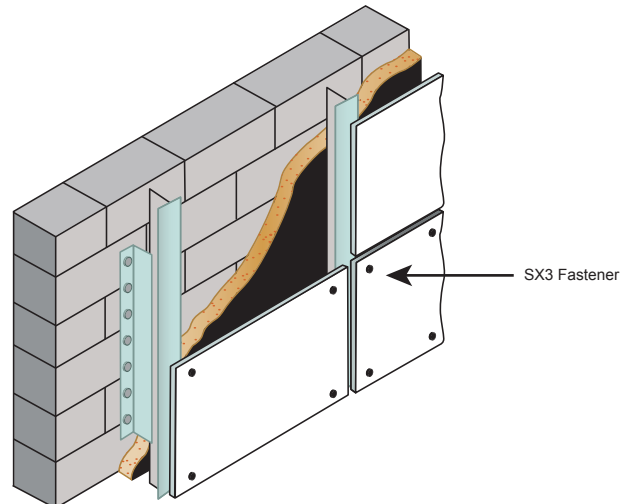

SFS intec Fastener Color Selection



SFS intec Fastener Color Codes

SFS intec fasteners are available with a plain finish or painted to color match Stonewood Architectural Panels in solid colors and woodgrains. Use the color chart to identify the fastener color code for each Stonewood Panel color.

Fastener colors for Wood Grain Panels



White Barn
Fastener Color Code: 827



Fonthill Pear
Fastener Color Code: 1376



Brighton Walnut
Fastener Color Code: 875



Blonde Echo
Fastener Color Code: 1552



Biltmore Cherry
Fastener Color Code: 1254



Cocobala
Fastener Color Code: 229



Raw Chestnut
Fastener Color Code: 1552



Windsor Mahogany
Fastener Color Code: 1654



Valencia Teak
Fastener Color Code: 324



New Age Oak
Fastener Color Code: 020



Mambo
Fastener Color Code: 1256



5th Ave Elm
Fastener Color Code: 1914



Monticello Maple
Fastener Color Code: 1382



Figured Mahogany
Fastener Color Code: 1477

Actual colors may vary from the color on your screen or printed copy.

Fastener Supplier

To purchase or for technical support on these austenitic stainless steel cladding fasteners, please contact SFS intec directly:

SFS intec
Division Construction
1045 Spring Street, Box 6326
Wyomissing, PA 19610

Tel: 1-610-790-2629
Fax: 1-610-376-8551
www.sfsintecusa.com





















SFS intec Fastener Color Selection

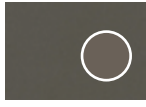

SFS intec Fastener Color Codes

SFS intec fasteners are available with a plain finish or painted to color match Stonewood Architectural Panels in solid colors and woodgrains. Use the color chart to identify the fastener color code for each Stonewood Panel color.

Fastener colors for Solid Panels

	White Fastener Color Code: 014		Mercury Fastener Color Code: 1588		Lapis Blue Fastener Color Code: 1692
	Designer White Fastener Color Code: 014		North Sea Fastener Color Code: 578		Atlantis Fastener Color Code: 2001
	Beige Fastener Color Code: 1573		Foundry Fastener Color Code: 091		Spicy Flavors Fastener Color Code: 1489
	Pebble Fastener Color Code: 1569		Ingot Grey Fastener Color Code: 051		Coffee Bean Fastener Color Code: 272
	Bridal Blanco Fastener Color Code: 557		Slate Grey Fastener Color Code: 051		
	Solid Grey Fastener Color Code: 1138		Black Fastener Color Code: 023		
	Fashion Grey Fastener Color Code: 1530		Aqua Lagoon Fastener Color Code: 2709		
	Platinum Fastener Color Code: 1588		Blue Caraibe Fastener Color Code: 1442		

Actual colors may vary from the color on your screen or printed copy.

Fastener Supplier

To purchase or for technical support on these austenitic stainless steel cladding fasteners, please contact SFS intec directly:

SFS intec
Division Construction
1045 Spring Street, Box 6326
Wyomissing, PA 19610

Tel: 1-610-790-2629
Fax: 1-610-376-8551
www.sfsintecusa.com



SFS intec Fastener Color Selection



SFS intec Fastener Color Codes

SFS intec fasteners are available with a plain finish or painted to color match Stonewood Architectural Panels in solid colors and woodgrains. Use the color chart to identify the fastener color code for each Stonewood Panel color.

Fastener colors for Abstract Panels



Italian White
Fastener Color Code: 850



Pewter Brush
Fastener Color Code: 578



Graphite Spectrum
Fastener Color Code: 1481



Grey Mesh
Fastener Color Code: 1100



Satin Stainless
Fastener Color Code: 1161



Pewter Mesh
Fastener Color Code: 422



Astro Strandz
Fastener Color Code: 1302



Carbon Mesh
Fastener Color Code: 1481

Actual colors may vary from the color on your screen or printed copy.

Fastener Supplier

To purchase or for technical support on these austenitic stainless steel cladding fasteners, please contact SFS intec directly:

SFS intec
Division Construction
1045 Spring Street, Box 6326
Wyomissing, PA 19610

Tel: 1-610-790-2629
Fax: 1-610-376-8551
www.sfsintecusa.com



SFS intec Fastener Color Selection



SFS intec Fastener Color Codes

SFS intec fasteners are available with a plain finish or painted to color match Stonewood Architectural Panels in solid colors and woodgrains. Use the color chart to identify the fastener color code for each Stonewood Panel color.

Fastener colors for Stonewood Select Panels



Greystone Pine
Fastener Color Code: 1849



Terra Impression
Fastener Color Code: 1656



Granary Pine
Fastener Color Code: 3996



Chalked Oak
Fastener Color Code: 879



Metropolitan Walnut
Fastener Color Code: 1869



Madison Walnut
Fastener Color Code: 110



Mineral Impression
Fastener Color Code: 850



Washington Cherry
Fastener Color Code: 1630



Carbon Oak
Fastener Color Code: 1249



Rotary Ply
Fastener Color Code: 961



Nantucket Oak
Fastener Color Code: 940



Bronze Impression
Fastener Color Code: 230



Harvest Ply
Fastener Color Code: 1572



Cask Oak
Fastener Color Code: 1650



Loft Ash
Fastener Color Code: 416

Actual colors may vary from the color on your screen or printed copy.

Fastener Supplier

To purchase or for technical support on these austenitic stainless steel cladding fasteners, please contact SFS intec directly:

SFS intec
Division Construction
1045 Spring Street, Box 6326
Wyomissing, PA 19610

Tel: 1-610-790-2629
Fax: 1-610-376-8551
www.sfsintecusa.com

