

# SFS intec Fastener Technical Bulletin



Fibersin recommends 300 series austenitic stainless steel cladding fasteners by SFS intec, Inc. when installing Stonewood Architectural Panels for exterior rainscreen applications.

300 series austenitic stainless steel cladding fasteners are specifically designed to be corrosion resistant and are available with plain finish and in colors matched to Stonewood Architectural Panels.

## Application

### SX3 TORX® Fastener



SFS intec Part #: 1271253  
 Code: SX3/15-D12-5,5X30  
 Description: 12-11 x 1-3/16"  
 Head Style: T25 TORX® Pan Head  
 Diameter: Nominal #12  
 Drill Capacity: .060"-.118"  
 Max. Material Attachment: .590"

### SX3-L12 *irius*® Fastener



SFS intec Part #: 1235713  
 Code: SX3/15-L12-5,5X32  
 Description: 12-11 x 1-1/4"  
 Head Style: *irius*® low profile and drive system  
 Diameter: Nominal #12  
 Drill Capacity: .060"-.118"  
 Max. Material Attachment: .590"

SX3 TORX® and SX3-L12 *irius*® are austenitic stainless steel fasteners with a bi-metal welded carbon steel point.

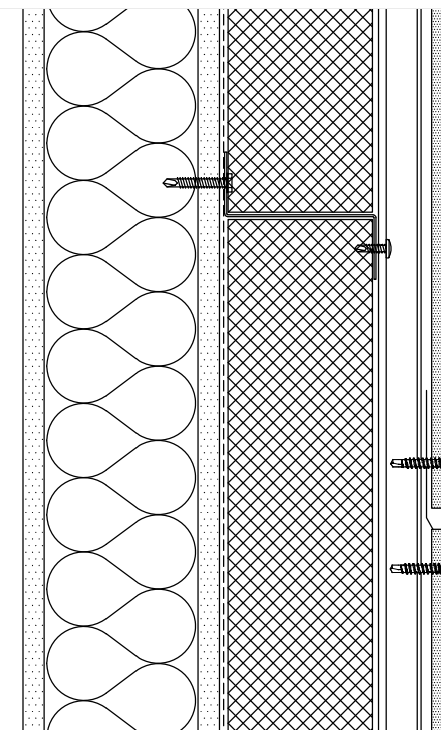

#### Installation:

Maximum material attachment (.590") is from underside of head to end of stainless steel thread.

0-2000 rpm screw gun equipped with depth sensing nosepiece. T25 TORX® drive bit required for SX3 TORX.

E420 *irius*® drive socket (#973316) required for SX3-L12 *irius*®.

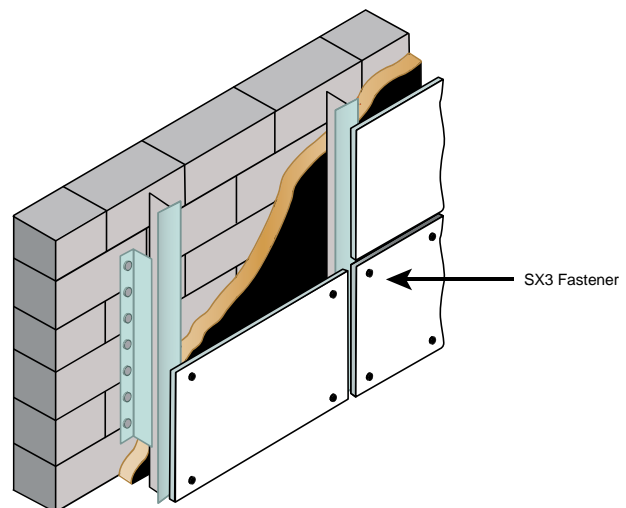



















# SFS intec Fastener Color Selection











## SFS intec Fastener Color Codes

SFS intec fasteners are available with a plain finish or painted to color match Stonewood Architectural Panels in solid colors and woodgrains. Use the color chart to identify the fastener color code for each Stonewood panel color.

### Fastener colors for wood grain panels

 Ivorywood / TPA721300 Fastener Color Code: 827	 Victorian Cherry / FP574 Fastener Color Code: 1654	 Montana Walnut / TPA63100 Fastener Color Code: 110
 Blonde Echo / TPA793900 Fastener Color Code: 1552	 Biltmore Cherry / TPA792400 Fastener Color Code: 1254	 Columbian Walnut / TPA794300 Fastener Color Code: 374
 Uptown Walnut / TPA797100 Fastener Color Code: 1371	 Windsor Mahogany / TPA60300 Fastener Color Code: 1654	 Cocobala / TPA7942 Fastener Color Code: 229
 Monticello Maple / TPA792500 Fastener Color Code: 1382	 Figured Mahogany / TPA66200 Fastener Color Code: 1477	 Valencia Teak / TPA000013 Fastener Color Code: 374
 Fonthill Pear / TPA1074500 Fastener Color Code: 1376	 Kenya Mahogany / TPA7958 Fastener Color Code: 1477	 Asian Night / TPA7949 Fastener Color Code: 324
 Wild Cherry / TPA65400 Fastener Color Code: 1409	 Mambo / TPA794800 Fastener Color Code: 1256	 Aloe / TPA796200 Fastener Color Code: 1852

### Fastener colors for solid panels (continued on next page)

 Pebble / FP584 Fastener Color Code: 1234	 Designer White / FP692 Fastener Color Code: 014	 New Platinum / FP537 Fastener Color Code: 1849
 Antique White / FP657 Fastener Color Code: 1486	 Fashion Grey / FP670 Fastener Color Code: 1530	 Mercury / FP447 Fastener Color Code: 1588
 White / FP202 Fastener Color Code: 014	 Platinum / FP514 Fastener Color Code: 1588	 Warm Neutral / 15013 Fastener Color Code: 850

Actual colors may vary from the color on your screen or printed copy.

### Fastener Supplier

To purchase or for technical support on these austenitic stainless steel cladding fasteners, please contact SFS intec, Inc. directly:

SFS intec, Inc.  
Division Construction  
1045 Spring Street, Box 6326  
Wyomissing, PA 19610

Tel: 1-610-790-2629  
Fax: 1-610-376-8551  
www.sfsintecusa.com











# SFS intec Fastener Color Selection

















## SFS intec Fastener Color Codes

SFS intec fasteners are available with a plain finish or painted to color match Stonewood Architectural Panels in solid colors and woodgrains. Use the color chart to identify the fastener color code for each Stonewood panel color.

### Fastener colors for solid panels (continued from previous page)

 Ingot Grey / FP753 Fastener Color Code: 051	 Black / TPA1595 Fastener Color Code: 023	 Lapis Blue / TPA00017 Fastener Color Code: 1692
 Foundry / FP750 Fastener Color Code: 091	 Onyx / FP720 Fastener Color Code: 023	 Green Tea / FP752 Fastener Color Code: 1653
 Slate Grey / FP637 Fastener Color Code: 051	 Blue Caribe / 733 Fastener Color Code: 1442	 Spicy Flavors / FP755 Fastener Color Code: 1489

### Fastener colors for abstract panels

 Italian White / FP725 Fastener Color Code: 850	 Cosmic Strandz / TPA494100 Fastener Color Code: 1539	 Carbon Mesh / TPA4880 Fastener Color Code: 1481
 Ebony Star / TPA4552 Fastener Color Code: 1040	 Pewter Brush / FP728 Fastener Color Code: 578	 Ice Fishin Pionite / TPA000024 Fastener Color Code: 014
 Rustic Slate / TPA 4888 Fastener Color Code: 324	 Antique Brush / TPA482300 Fastener Color Code: 1592	 Cloud Zephyr / TPA4856 Fastener Color Code: 370
 Graphite Spectrum / FP612 Fastener Color Code: 1481	 Grey Mesh / TPA487700 Fastener Color Code: 1100	 Basket Weaving / FP744 Fastener Color Code: 001
 Satin Stainless / TPA4830 Fastener Color Code: 1161	 Pewter Mesh / TPA487800 Fastener Color Code: 422	

Actual colors may vary from the color on your screen or printed copy.

### Fastener Supplier

To purchase or for technical support on these austenitic stainless steel cladding fasteners, please contact SFS intec, Inc. directly:

SFS intec, Inc.  
Division Construction  
1045 Spring Street, Box 6326  
Wyomissing, PA 19610

Tel: 1-610-790-2629  
Fax: 1-610-376-8551  
www.sfsintecusa.com

